

HM 1095 Mono Black – 295_{el} / 719_{th} W_p

Monocrystalline PV and thermal panel

Features

- ✓ Optimized solar coverage
Power and Warmth – one module
- ✓ Advanced absorber engineering
for full surface heat absorption
- ✓ Higher efficiency
through active cell cooling
- ✓ Snow-free in winter
Defrosting effect due to water cycle
- ✓ Positive performance variation
From 0W to +5W for a better yield
- ✓ Powerful and lightweight - only 24 kg (53 lbs - filled)
Snow load: 5400 N/m² (502 N/ft)
Wind load: 2400 N/m² (223 N/ft)
- ✓ Product Guarantee: 10 years
Performance Guarantee: 10 years 90% — 25 years 80%
- ✓ **Quality made in Germany**



Technical Data

Testing conditions	STC	NOCT
Nominal voltage (V_{mpp})	32,52 V	29,73 V
Nominal current (I_{mpp})	9,07 A	7,40 A
Open circuit voltage (V_{oc})	39,15 V	36,24 V
Short circuit current (I_{sc})	9,77 A	7,91 A
Electrical power (P_{max})	295 W	215 W
Thermal power (P_{max})	719 W	557 W
Maximum operating pressure (P_{max})	4 bar (58 psi)	
Max. operating voltage	1000 V	

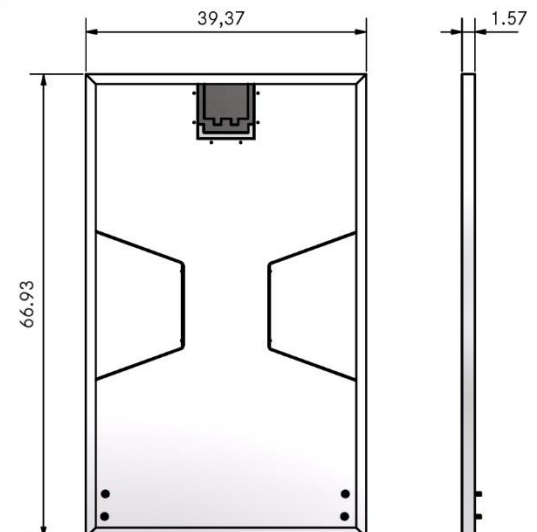

STC: Irradiation 1.000 W/m², panel temperature 25°C (77°F), air mass = 1,5
NOCT: Irradiation 800 W/m², ambient temperature 20°C (68°F), wind speed 1 m/s (2,24 mph)